

ABLOY® PROTEC

High security office furniture locks



ABLOY® PROTEC is the culmination of 90 years of world-leading development of the rotating disc cylinder.

CABINET LOCKS

DIMENSIONS

APPLICATIONS

Reliable locks for metal or wooden furniture, medicine chests, sets of drawers, wardrobes, sliding doors etc.

OF205N with double hook bolt is specially designed for furniture where extra security is needed.

Locks are suitable for surface or recessed fitting with flat bolts, hook bolts or spring latch bolts, on doors and drawers from 0.5 mm to 35 mm in thickness.

The locks with 11 discs -OF200N, OF201N, OF202N, OF205N, OF206N, OF207N and OF208N -can be master keyed with any other ABLOY® PROTEC lock. The models with 7 discs OF212N, OF213N, OF214N, OF215N, OF216N and OF217N can be master keyed with each other.

MATERIAL AND FINISH

Cylinder housing of chrome-plated zinc. Lock case, striker plate and bolt of nickel-plated steel. The latch bolt of OF202N and OF217N is of brass. Spacer piece of plastic.

PACKAGE

The package includes a lock with 2 keys. ABLOY® PROTEC OF214N and OF208N include the striker plate 434987 as standard. When ordering other models the code of the striker plate has to be specified.

OF200N, OF201N
OF215N, OF216N

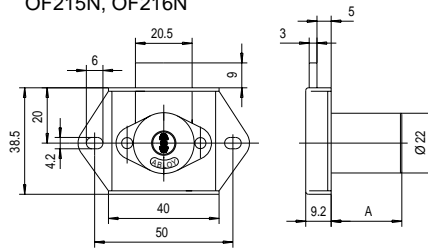

	A
OF200N	25.5
OF201N	25.5
OF215N	19.5
OF216N	19.5

OF202N
OF217N

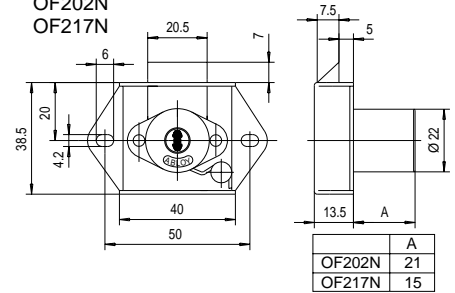

	A
OF202N	21
OF217N	15

OF206N, OF207N
OF212N, OF213N

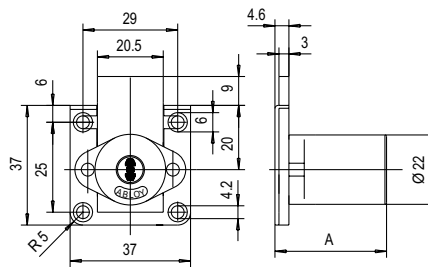

	A
OF206N	35
OF207N	35
OF212N	29
OF213N	29

OF205N

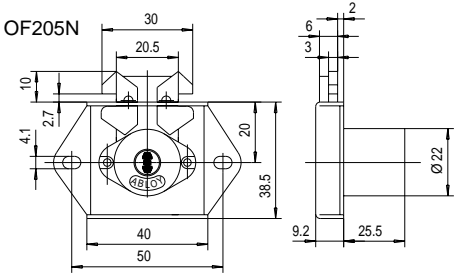

OF208N
OF214N

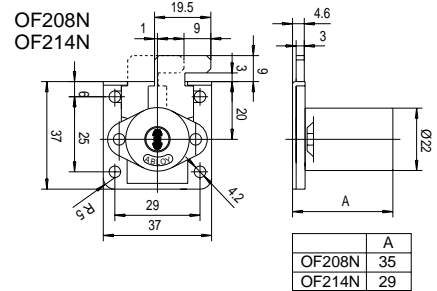

	A
OF208N	35
OF214N	29

FITTING SUGGESTIONS

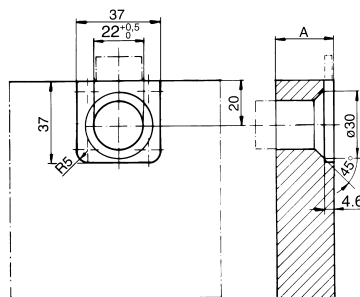

Lock	A max
OF212N, 213N, 214N	29
OF206N, 207N, 208N	35
OF210N	35

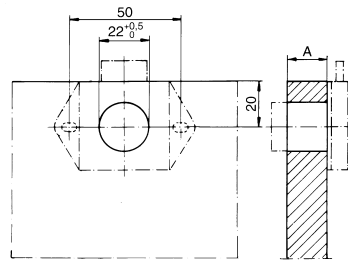

Lock	A max
OF215N, 216N	19.5
OF217N	15
OF200N, 201N	25.5
OF202N	21

OF205N

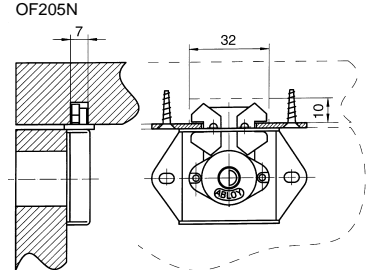

LOCK TYPE

	OF212N	OF214N	OF215N		OF200N			OF206N	OF208N
Key removable in locked and unlocked positions									
Key removable in locked position only	OF213N		OF216N	OF217N	OF201N	OF202N	OF205N	OF207N	
DIMENSIONS									
Cylinder protrusionA (mm)	29	29	19.5	15	25.5	21	25.5	35	35
Door thickness	12-29	12-29	0.5-19.5	0.5-15	0.5-25.5	0.5-21	0.5-25.5	12-35	12-35
TYPE OF BOLT	flat	hook	flat	spring latch	flat	spring	double hook	flat	hook
NUMBER OF DISCS	7	7	7	7	11	11	11	11	11
CYLINDER	zinc	zinc	zinc	zinc	zinc	zinc	zinc	zinc	zinc
STRIKER PLATE	434980 434981 455365	434987	434980 434981 455365	434980 434981 455365	434980 434981 455365	434980 434981 455365	802330	434980 434981 455365	434987
WEIGHT /10 PCS (kg)	1.06	1.04	1.2	1.26	1.48	1.57	1.55	1.34	1.36

PUSH BUTTON LOCKS

DIMENSIONS

APPLICATIONS

The most reliable security locks for sliding doors on office furniture, showcases, merchandising sections, metal cabinets, sliding glass units, etc. Locks OF404N and OF400N are specially designed for wooden units, OF407N for glass units and OF406N and OF408N for metal units or doors. Equipped with a special fixing plate the use can be remarkably extended. The thickness of the door or drawer must be minimum 8 mm.

Otherwise a special sleeve collar should be used to cover the hole on the side of the cylinder housing. OF401N and OF405N is specially designed for glass sliding doors with aluminium profile.

ABLOY® PROTEC OF400N, OF402N, OF403N and OF405N can be master keyed with any other ABLOY® PROTEC lock. The locks with 7 discs – OF404N, OF406N, OF407N, OF408N, OF401N can be master keyed with each other.

MATERIAL AND FINISH

Cylinder housing and OF403N/OF407N mounting ring of chrome-plated zinc. Collar and escutcheon ring of chrome-plated brass. Bolt of nickel-plated steel. OF401N and OF405N available only in satin chrome (H).

PACKAGE

The package includes a lock with screws and 2 keys.

OF400N
OF404N

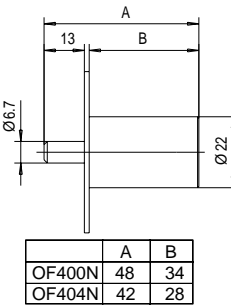
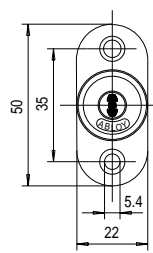

OF403N
OF407N

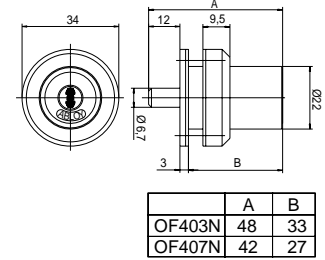

OF401N
OF405N

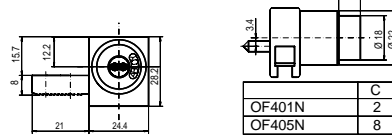
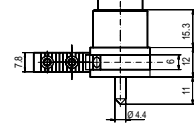

OF406N

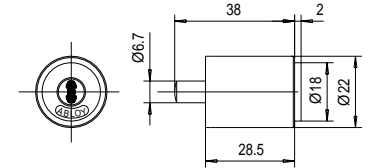

OF402N

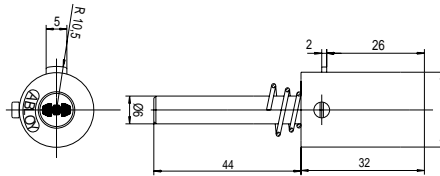

OF408N

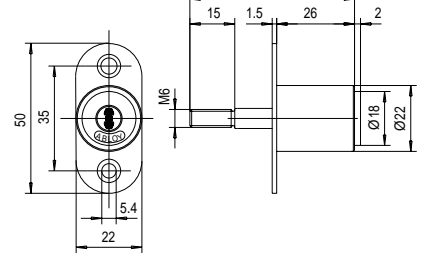

FITTING SUGGESTIONS

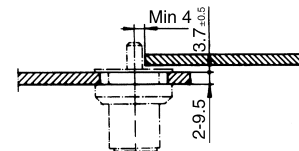
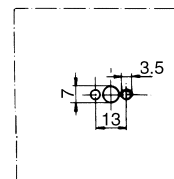
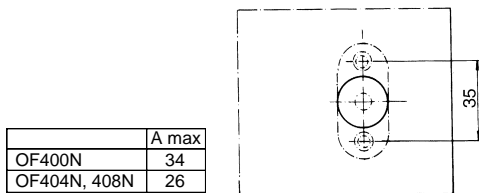
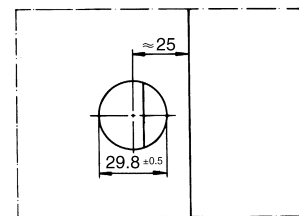
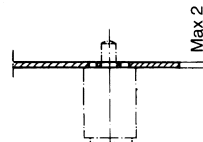
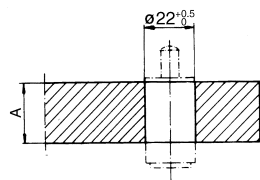

Lock type OF406N

Lock type OF407N, OF403N

LOCK TYPE

	OF400N	OF401N	OF402N	OF403N	OF404N	OF405N	OF406N	OF407N	OF408N
CYLINDER HOUSING/ OUTER SLEEVE	zinc	zinc	zinc	zinc	zinc	zinc	zinc	zinc	zinc
DIMENSIONS Overall length (mm)	48		76	48	42		40	42	57
Length of the housing	34			33	28		30.5	27	28
DOOR THICKNESS (mm)	12-34			2-9.5	12-26		0.5-2	2-9.5	12-26
NUMBER OF DISCS	11	7	11	11	7	11	7	7	7
WEIGHT/ 10 pcs (kg)	1.22	0.90	0.70	1.20	1.02	1.10	0.98	1.38	1.07

CABINET LOCKS WITH CENTRAL LOCKING BAR

APPLICATIONS

These locks are used for central locking of office furniture. The locks with 11 discs – OF 203N and OF210N and can be master keyed with any other ABLOY® PROTEC lock. The key is removable in both locked and unlocked positions.

MATERIAL AND FINISH

Cylinder housing of chrome-plated zinc. Lock case and bolt of nickel-plated steel. Spacer piece of plastic.

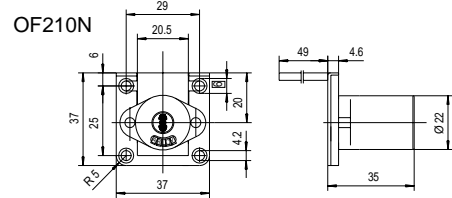
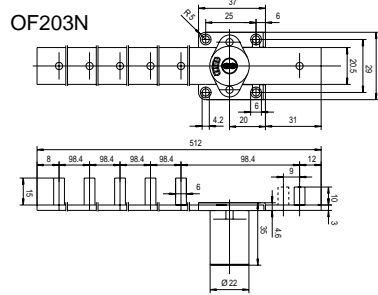

PACKAGE

The package includes a lock with 2 keys.

ACCESSORIES

STRIKER PLATES

Striker plates are of nickel-plated steel. The code for ordering are as follows: 802330, 434987, 434981, 434980, 455365.

ESCUTCHEON RING

Material as standard is chrome-plated brass. Available also in other finishes. The codes for ordering according to the finish:

- 401746 chrome
- H401747 satin chrome
- M455142 brass

DIMENSIONS

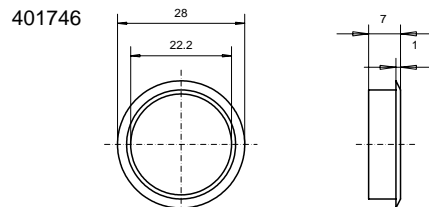

Please Note!
When using an escutcheon ring the diameter of the fitting hole must be 23-24 mm, and the maximum door thickness can be up to 4 mm thicker than the one mentioned in the table.

KEEP

Made of nickel-plated brass. The code for ordering is 401930.

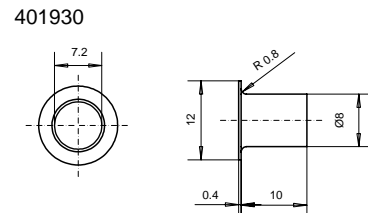

DIMENSIONS

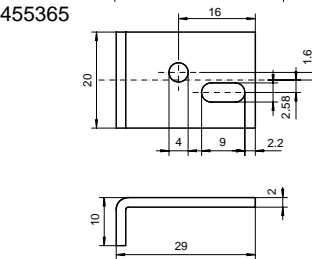
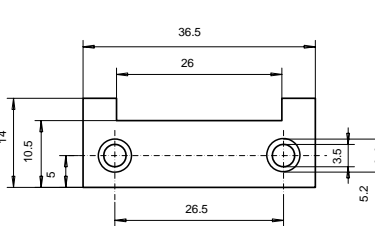
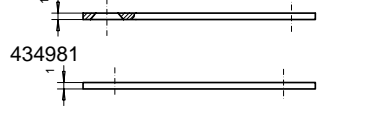
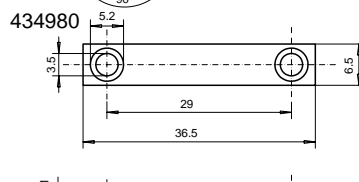
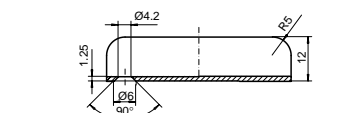
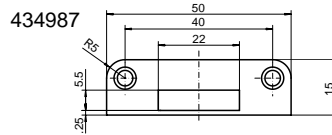
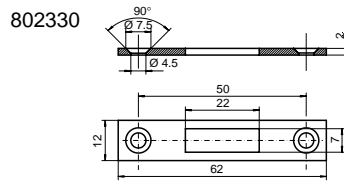

FITTING SUGGESTION

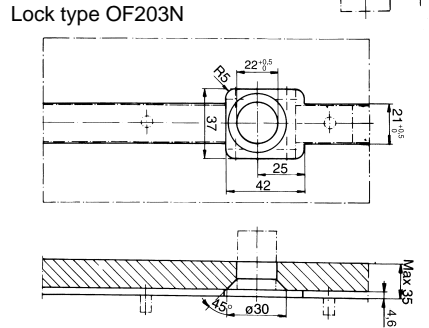
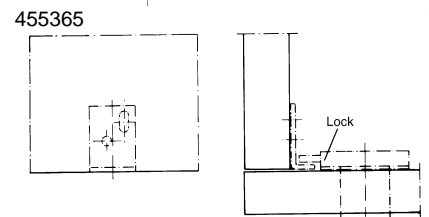
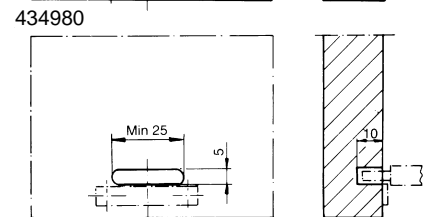
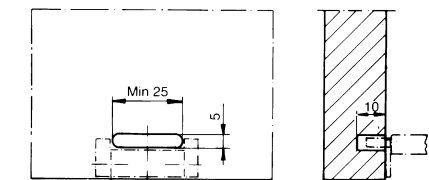
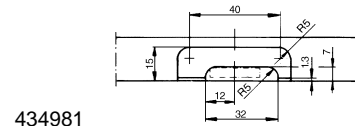
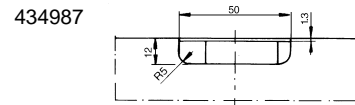

Abloy Oy
Wahlforssinkatu 20
P.O. Box 108
FIN-80101 JOENSUU
FINLAND
Tel. +358 13 2501
Fax +358 13 250 2209

www.abloy.com

